

Digital position indicators

direct drive, 3-digit counter, technopolymer

BASE AND CASE

High-resistance polyamide based (PA) technopolymer. Black base.

Case in the following colours:

- **C2**: RAL 2004 orange, glossy finish.
- **C3**: RAL 7035 grey, glossy finish.
- **C1**: RAL 7021 grey-black, glossy finish.

The ultrasonically welding between the base and the case prevents separation and avoids dust penetration.

WINDOW

Transparent polyamide based (PA-T) technopolymer, moulded over the case and with a perfect seal. Resistant to solvents, oils, greases and other chemical agents (avoid contact with alcohol during cleaning operations).

DISPLAY

It indicates the displacement of the mechanism controlled by the spindle from the start position (0).

Three-digit roller counter. The digits of red rolls show the decimal values.

The display can be in different positions (see "Table of the possible combinations").

- **AN**: inclined display, counter in upper position.
- **AR**: inclined display, counter in lower position.
- **FN**: front display, counter in upper position.
- **FR**: front display, counter in lower position.

INTERNAL GASKET

O-ring front sealing in NBR synthetic rubber, between the case and the bushing.

REAR GASKET

Foam polyethylene, supplied.

STANDARD EXECUTION

Bushing with $\varnothing 10$ mm H7 reamed hole, fitting to shaft by means of a supplied grub screw with hexagon socket and cup end, included in the supply.

- **DD50**: black-oxide steel bushing.
- **DD50-SST**: AISI 303 stainless steel bushing.

DIRECTION OF ROTATION

- **D**: clockwise. Increasing values with clockwise rotation of the bushing.
- **S**: anti-clockwise. Increasing values with anti-clockwise rotation of the bushing.

WEIGHT

22 grams.

ERGONOMY AND DESIGN

Compact roller counter, ergonomically designed digits for rapid reading. The readability of the counter is increased by the magnifying window.

ASSEMBLY INSTRUCTIONS

1. Drill a $\varnothing 6$ mm by 10 mm hole in the body of the machine with a 18 mm centre distance from the spindle to fit the rear referring pin.
2. Set the spindle to the start or referring position.
3. Fit the indicator with the zeroed roller counter onto the spindle and make sure that the referring pin fit the hole.
4. Clamp the bushing to the spindle by tightening the grub screw with hexagon socket and cup end, according to UNI 5929-85.



ELESA Original design

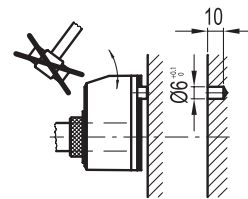
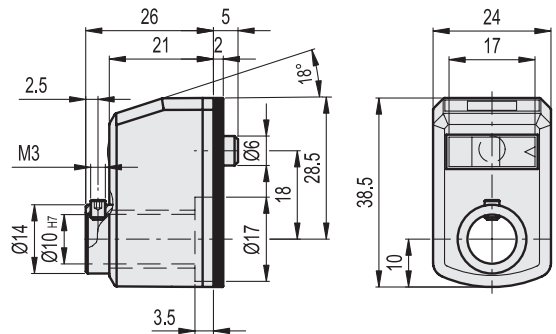

SPECIAL EXECUTIONS ON REQUEST

- Special readings after one revolution.
- Case in different colours.
- Completely sealed digital position indicators with IP 67 protection class, see table IEC 529 (on page) obtained by means of a brass bushing with double seal ring inside the rear cavity of the base.

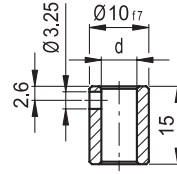

FEATURES AND APPLICATIONS

Direct drive digital position indicators can be assembled on passing through spindles in any position to give direct reading of the positioning of a machine component. They are suitable also for motor driven applications (see below "Guide to the choice of standard combinations")

ACCESSORIES ON REQUEST (TO BE ORDERED SEPARATELY)

- **MDX-50**: polyamide based (PA) technopolymer knob.
- **RB50**: black-oxide steel reduction sleeves.
- **RB50-SST**: AISI 304 stainless steel reduction bushing.

RB50







Code	Description	dH7
CE.80940	RB50-6	6
CE.80950	RB50-8	8

RB50-SST

STAINLESS STEEL

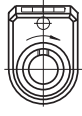
Code	Description	dH7
CE.90940	RB50-6-SST	6
CE.90950	RB50-8-SST	8

Example of description for ordering

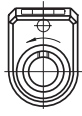
DD50	-	AN	-	003	-	D	-	C2	-	SST
Series		Display position		Reading of the counter after one revolution		Increasing numbering		Colour		Stainless steel boss
										
AN		AR				D clockwise		C2 RAL 2004		To add only for the version with stainless steel boss
								C3 RAL 7035		
FN		FR				S anti-clockwise		C1 RAL 7021		

003	003	003	Pitch	Speed (rpm) *
003	00.3	0.03	0.3	1500
010	01.0	0.10	1.0	1500
020	02.0	0.20	2.0	1250
030	03.0	0.30	3.0	830
040	04.0	0.40	4.0	625
050	05.0	0.50	5.0	500
100	10.0	1.00	10	250

* The maximum rotation speed (rpm) of the spindle reported in the table corresponds to a maximum rotation of 25000 units of the last roll on the right of the counter.
Rotational speed tests have been performed in our laboratory under standard operating conditions. Small misalignments (not compromising the correct reading) of counter digits can occur due to high tolerances between gear teeth, designed to prevent damage from sudden acceleration or stop.

